

Varenummer: 0108069
 Beskrivelse: Seeger låsering JK 52 DIN 984

Mål

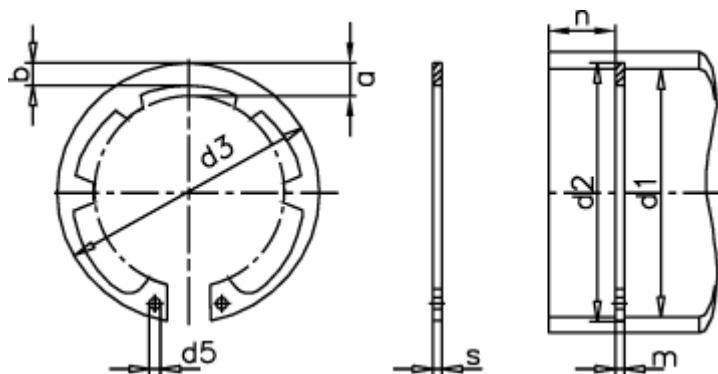

a max	= 8.2	d5 min	= 2.5	s	= 2.00
AN mm ²	= 252.0	FN kN	= 42.0	t	= 1.50
Antal takker	= 6	FRg kN	= 12.0	Tang	= ZGJ-3
b	= 4.7	FR kN	= 60.2	tol	= -0.07
Betegnelse	= JK 52	g	= 2.0	tol	= +1,10-0,46
d1	= 52	K kN-mm	= 108.0	tol	= +0,30
d2	= 55.0	m min	= 2.15	vægt kg/1000	= 9.40
d3	= 56.2	Nominal træk	= 4.5		